

# LPG Fogger Type ANEL-FOGP & ANEL-FOGB

## *Manual & Maintenance*

**IMPORTANT :** Read this directions of use carefully so you will be familiar with the use of the device before you connect the LPG GAS bottle . Keep this manual for future reference

### THE FIRST STEPS:

Know your product and its uses (see. Diagram).

1. Container for liquid: The container contains the liquid to be fogged . Use only products suitable for thermal spraying (food grade mineral oil, glycerin - water in a ratio of 10% to 50%).
2. Handle / body : Leads the to be fogged liquid from the tank to the heating element. On the back there is the adaptor for the LPG gas bottle (not included) .Thanks to the burn of the LPG gas the process of fogging takes place . In – On the Handle/body there are :
  3. Valve for LPG gas : Located on the side of the handle. The valve regulates the Fuel that will be burned so heat will be produced around the spiral tube that carries the liquid . The liquid will become hot and when it will be exposed in the open air its molecules will be expanded and fog will be created . **Before storing the Fogger , you should always make sure the fuel valve is closed, ( turned firmly clockwise ).**
  4. Handle-Trigger : Underneath the handle there is a trigger. With the trigger you can choose when to feed the heated tube with liquid so you will produce fog .
  5. Safety : This button is located at the front and up of the Handle. Pressing the button from right to left ( Off ) , locks the trigger . Then you can not press the trigger. When Fogger is not used but also during the ignition – start up process , the trigger should always be locked and pressed from the right side to the position Off .
  6. Igniter - Under the Security of Trigger there is the Igniter bottom . Pressing the igniter having open GAS fuel valve, created a spark on the heated element at the front that start the fuel burning . To verify the proper operation of the igniter, go into a dark room and press the igniter button, without connecting the propane bottle. Normally, between the heat element and the spiral heated tube you should see a spark. If you can not see spark the the ignitor does not work . You can light on the Fogger with a lighter or a match following the instructions below .
  7. Heat element : The heat element is protected by a grid located at the opposite end of the LPG adaptor . At this fog is released . **ATTENTION, this point is very HOT. TAKE CARE NOT TO TOUCH ANY POINT WITH YOUR BODY , animal or other object .**
  8. Spiral tube . The spiral tube starts from the end of the Bottle for liquid , pass through the inside of the body of the fogger , surrounds the heat element and exits at the front of the Fogger . It carries the liquid that will be fogged
  9. Pumping system . It is connected with the trigger and the spiral tube . Each time you press the trigger the pump push a quantity of ~2ml into the spiral tube

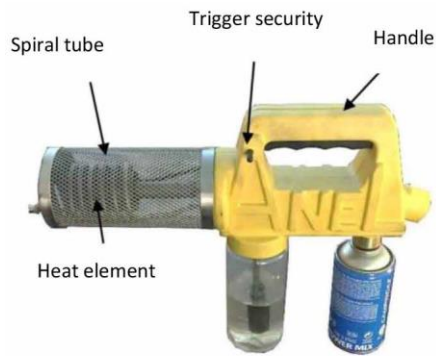

**ANEL-FOG-B**

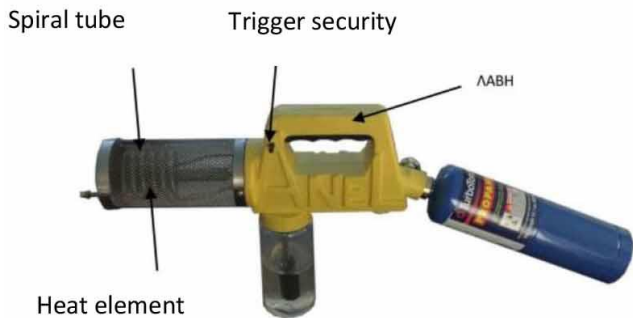
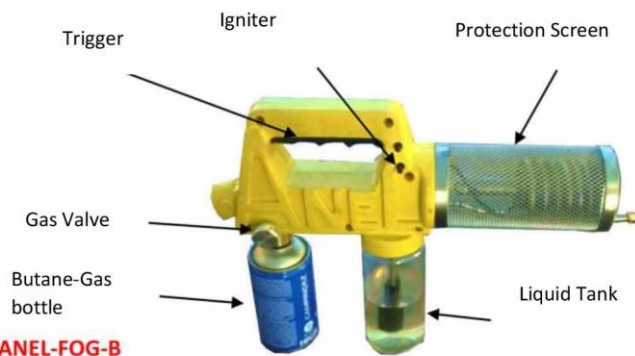

**ANEL-FOG-P**

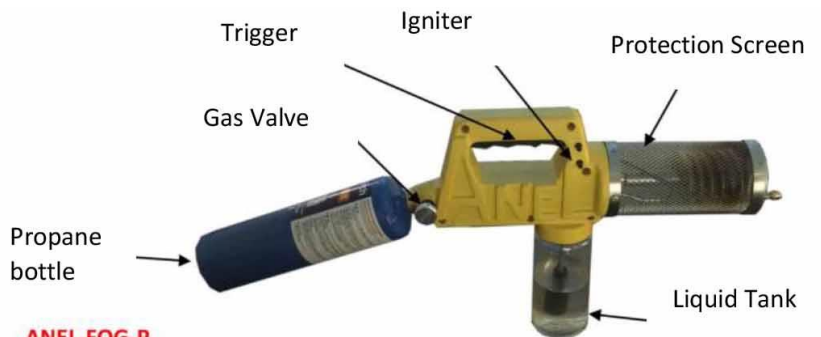

Drawing I

### PREPARATION

1. Safety button: Click the button on the front of Fogger to lock the trigger in the position Off .
2. Liquid Container : Fill the plastic container with the liquid to be fogged . Avoid overfilling. Screw the container, firmly . Use of any product other than special chemical products for use in thermal sprayers may result in clogging of the system, making it unsafe operation of fogging and voids the warranty.
3. Close the LPG gas valve: Valve is at the right side of the fogger . Make sure the valve is closed ( clockwise ) .
4. Insert the bottle of LPG gas : Check the drain at the back of Fogger . Ensure the cleanliness of the bottle and Fogger . There should be no residues. Gently push the cartridge in the pipe and screw it clockwise until the bottle is properly inserted. Tighten by hand.

### OPERATION OF FOGGER

1. Pull the trigger to make sure it is locked. The trigger should not move.
2. For the ignition and preheat of the Fogger , you should always be sure that it is placed on a horizontal position .
3. Turn counterclockwise, to open the valve on the propane fuel, no more than 1/4 of a full rotation.
4. Press the igniter button to create a spark. It will ignite the fire on the heat element .
5. If the heat element is not activated, close the valve of the fuel. Wait 1 minute and then repeat the ignition process. Move away a little from the point at which you made the first attempt to avoid the fumes that are released at that point.
6. If the igniter fails to light the heat element , close the fuel valve and wait one minute. Using a lighter or a match, beneath the heat element so the flame touch its surface and turn slowly the valve on the propane fuel until the heat element lights on .

7. When heat element lights on, let Fogger to warm up for about 2-3 minutes. If you will not wait for a proper preheating you may not have the fogging results you want and you may cause damage to your fogger. **DO NOT TOUCH THE ELEMENT OR THE GRID OF RESISTANCE. IT IS EXTREMELY HOT ! KEEP THIS PRODUCT OUT OF REACH OF CHILDREN.**

8. Fogger is ready for use. Release the trigger safety (press it to the left side of the handle to the position ON).

9. To pump the liquid in the system, press the trigger repeatedly and smoothly every 3-4 seconds. If flames appear, STOP IMMEDIATELY pressing the trigger. The flame appearance is due to overflow of fogging liquid. Close the valve Fuel and place the Fogger on a non-combustible surface. Let Fogger there for about 10 minutes and start again from Step 1 of Operation Fogger.

10. Use Fogger approximately 1.5 meters from the point where you want to spray with the wind on your back. This avoids the possibility of the air to bring the fog up your or at a place other than what you want. In case of beehive treatment keep a distance of 5-10cm from the entrance – bees.

### SETTING OFF THE FOGGER

1. Lock the trigger by pressing the trigger safety on the right to the position Off.

2. The liquid may still be fogged for a few minutes. Wait until it stops.

3. Close the valve on the propane fuel. It may take several seconds (5 - 10) until the LPG gas that is in the system will be completely burned. **THE HEAT ELEMENT WILL CONTINUE TO BE HOT FOR ABOUT 10 MINUTES, DO NOT TOUCH THE PROTECTION SCREEN. There will pass several minutes (even up to 20) until the temperature of the protection screen has arrived to the environment temperature (it depends on the environment temperature)**

4) Let the fogger to cool down by placing on a stable inflammable horizontal surface. The handle must be up.

### STORAGE

Proper Storage of Fogger

The Fogger should always be stored in a cool, well-ventilated place. Keep away from children.

1. Remove the LPG gas bottle before storage.

2. Empty the liquid from the bottle. If you have used corrosive liquids fill the liquid bottle with water, screw it on the fogger and pump until you will be sure you have well cleaned the spiral tube from the residues of the corrosive liquid.

3. Then empty the water, and place the bottle back in its position.

4. Never store Fogger with the fogging liquid in the container, otherwise there is a BIG POSSIBILITY you will damage the pump system and/or clog the spiral tube.

### OTHER USEFUL TIPS

When using the Fogger, grid resistance must always be parallel to the horizon. The fogger should always be upright (the handle up like the draw I, II), and never at side or upside down.

NEVER use Fogger directly to plants or shrubs, you may damage them.

**NEVER use Fogger at very high or very low temperatures or windy too. Danger of fire can be presented.**

The best time to use the Fogger is afternoon, since then the wind and temperatures allow the mist to settle the points you want.

The Fogger can be used to produce wet fog or dry fog. The frequency of the trigger pressure determines whether the spray will be wet or dry. For best results, we recommend that you press the trigger of Fogger every 3-4 seconds.

The fog should be white. If the color is brown or yellow, then you press the trigger very slowly. If the rate at which you press the trigger is too fast, then the edge of Fogger will accumulate moisture.

**IMPORTANT: Read these instructions carefully to familiarize yourself with the appliance before connecting the gas bottle. Keep the instructions for your future information.**

#### **SAFETY PRECAUTIONS**

1. During the burn of the LPG ( butane – propane ) there are created poisonous gasses . Avoid breathing vapors.
2. Should ALWAYS wait to warm up the Fogger having it horizontal in relation to the ground. If the heat element is not sufficiently warmed up, it may result in uncontrolled flame.
3. Use liquids as proposed or liquids that intended to be used in thermal Foggers.
4. When using the Fogger ALWAYS keep the heat element parallel to the horizon . If you turn the angle of Fogger downward, the liquid LPG will roll up uncontrolled and extended flame will be presented at the front of the appliance . In that case close the valve of LPG gas , wait 10 minutes and start again .
5. DO NOT OVERTIGHTEN THE VALVE OF THE FUEL propane. The Fogger will continue to run for a short (about 10 seconds ) , after closing the valve. If you tighten it too much you will cause serious damage to LPG gas system .
6. **For the type ANEL-FOGP you should use only the bottle LPG Turbotorch PROPANE 14.1 oz. If you use the small bottle maybe you will have the effect of uncontrolled fire . The use of different kind of LPG bottle than the one proposed may cause damage to the appliance and – or create serious danger for explosion or fire**
7. **For the type ANEL-FOGB you should use only the bottle Camping gaz MIX BUTANE /PROPANE 70%Butane/30%propane 170gr CG1750 . The use of different kind of LPG bottle than the one proposed may cause damage to the appliance and – or create serious danger for explosion or fire**
8. Always check the output of the fuel bottle and clean it if dirty.
9. You should use the Fogger only in well-ventilated areas. Never approach the Fogger close to flammable materials. Do not smoke while filling or using the appliance. Do not spray near uncovered foods, or naked flame. There is danger of pollution , fire or explosion.
10. Do not use the Fogger in places where there are people or animals. Keep Fogger , LPG gas bottle and liquid away from children.
11. The wrong connection of the LPG gas bottle will cause gas leakage. Ensure proper placement of the LPG gas bottle .
12. To check the safety of the connection of the LPG bottle and to be sure there is no leakage , pour some soapy water with the help of a sponge on the connections or whenever you wish to see if there is a LPG leakage . If you notice bubbles there is a leakage ! In this case disconnect the LPG bottle and place the bottle outdoors and away from children and fire . Try with another LPG bottle and test again with the soapy water . If you continue to see bubbles take the appliance to the store you have purchased it from .
13. Keep your face, hands and clothes away from the protection grid at the front of the apparatus . In operation of the apparatus, the protection grid becomes very hot.
14. The trigger should be unlocked only when spraying. Securing the trigger will prevent possible unwilling fogging . The accumulation of fluid in resistance may cause the liquid to be on fire when you turn on the device. Doing so may cause fire or stains on your clothes, carpets, etc., and is harmful to the grass and foliage.
15. You must ALWAYS supervise the Fogger when it works.
16. Check the seals.
17. Do not use the appliance if it has damaged or worn seals.
18. Do not use a device that is leaking, damaged or malfunctioning.
19. The devices are exclusively for outdoor use, or used in well ventilated areas to provide combustion air to avoid dangerous increase of unburned gas .
20. The device is being used away from flammable materials and at a distance of 20cm from adjacent surfaces. It works horizontally.
21. Gas cylinders must be changed in a well ventilated area, preferably outdoors, away from any ignition sources such as naked flames, pilots, electric sparks and away from other people.

22. If there is a leak in the appliance (smell of gas), Close the LPG valve and remove the appliance immediately in a well ventilated area where the leak can be located and stopped. If you wish to check for leaks on your device, this should be done outdoors. **Do not try to detect leaks using a flame**, use soapy water as described above .
23. CAUTION: Accessible parts may be very hot. Keep children away from the device.
24. After use, turn the LPG gas bottle valve to the closed position and then, after the flame turn of unscrew the LPG gas bottle and store it according to the directions of the manufacturer .
25. Avoid overfilling the container of liquid. Before refilling, set off the Fogger according to the instructions , wait for it to be to cool and then refill the container .
26. you should ALWAYS follow the instructions on the labels of the liquid you will use . Some liquids produce toxic gases and require special masks and filters .
27. The LPG gas bottles are under pressure. Always handle the bottles carefully. Follow the instructions on the bottles . Never damage an LPG gas bottle even if it is empty . **There is a great risk of explosion or-and fire with life threaten risk .**
28. Check and be sure that the heat elements is turned off and there is absolutely no evidence of fire on it or other part of the apparatus before disconnecting the LPG gas bottle. You should **NEVER** disconnect the LPG bottle when there is a fire on the heat element
29. Check the seals before connecting a new bottle in the device.
30. NEVER store the LPG gas bottles connected to Fogger . The bottle should always be stored in a cool, well-ventilated place and according to the directions of the manufacturer .
31. DO NOT burn the LPG gas bottles or the containers of the liquids to be fogged . You must arrange the proper disposal of empty bottles.
33. Do not modify the device.

## Troubleshooting Guide

Problem	Possible Cause	Corrective Action
The apparatus is not producing fogg – Heat element operates	An item or an impurity has clog the spray nozzle and / or the edge of the resistance	Remove the spray nozzle and check if it is clogged. Take it out ( counterclockwise ) clean it with a needle. Having removed the spray nozzle, use a pipe cleaner to remove the carbon that may have accumulated inside the Spiral Tube . Place the spray nozzle back again ( clockwise ) and tighten it well.
	The pump is clogged	Remove the container of liquid . Having the Fogger lying on its side, remove the plastic cover of the pump (watch the spring and the ring found on the inner side of the lid). Place a small wire in the hole at the bottom of the connection of the pump (thereby cleaning everything has possibly clogged). Carefully Put the plastic cover of the pump in place, making sure the spring and the ring are in its proper place .
	Damaged piston cask	See. Parts & technical support to next page
	Improper mist	Use only liquids proper for use in thermal fogger
Heat element does not switched on , or it runs off after a while	Empty propane bottle	Replace the propane bottle
	The container of gas is not properly connected	Check that the LPG bottle is properly connected
	Ignitor does not operate	Check the ignitor . Try to start the ignition with a lighter
Dripping liquid from the spray nozzle	The spray nozzle is too loose	Tighten the spray nozzle
	Overspray rate	Reduce the rate at which the trigger pullen
	The device is not at operating temperature	Wait 60 seconds before pressing the trigger again
	You did not properly terminate the device last time	Before you set off the device you must allow all remaining liquid to be fogged . If not then the next time you will light on the devise the remainings of the liquid qill be pushed of the Spiral tube as liquid and not as fogg. Wait a few seconds and fogg will start to be produced .
Poor quality of Fogg	Improper spray	Always use the recommended liquids
	Yellow-brown smoke	If the liquid that comes out is very thin or has a yellow-brown color, the rate at which you press the trigger is too low .Increase the rate at which you press the trigger.
	If the spray is very wet and liquid drips out of the spiral tube instead of fogg	Reduce the rate at which you pull the trigger
Intense or uncontrolled flame		The edge of Fogger faces to the ground. The device must be used in a horizontal position
Ignition of liquid that has been spoiled on the heat element		Stop immediately to press the trigger. Close the LPG gas valve. The flame will go out when the liquid that has been spoiled on the heat elemnt has been burned out
The piezoelectric igniter does not create a spark		The spark plug is damaged or iredulated . Fix it acording the directions below

## PARTS AND FACTORY TECHNICAL SUPPORT

If problems persist or if you need some of the parts listed below, contact us for more information and technical support.

NOTE: Do not send the device to the factory unless you have prior approval.

### Diagram of parts and spare parts

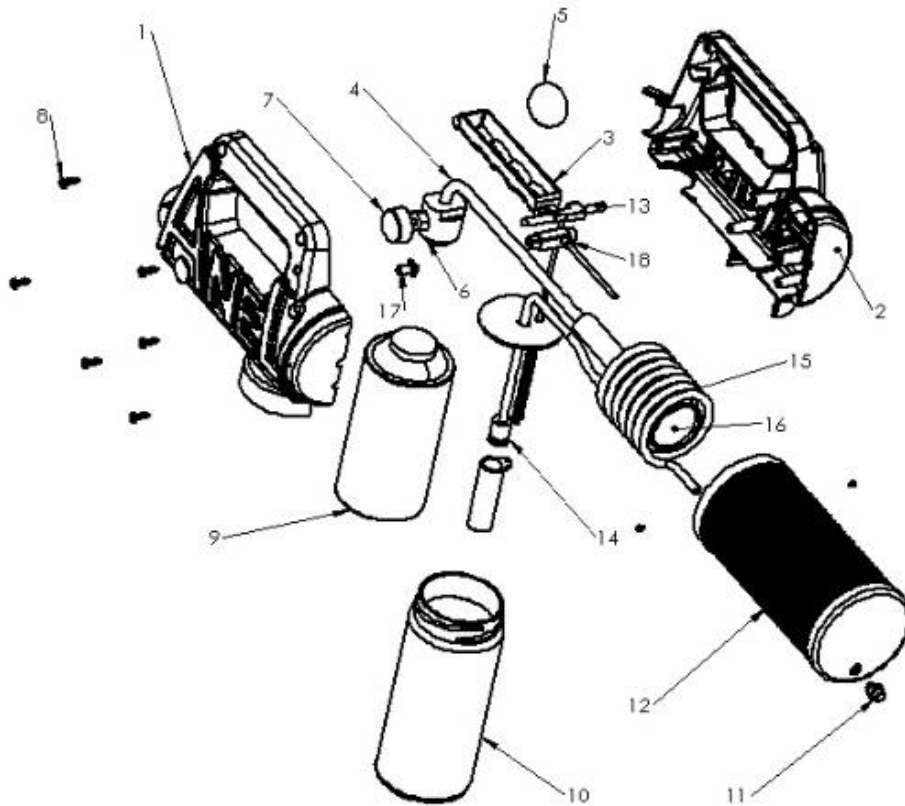

1. Right cover **AN600CO** (set)
2. Left Cover **AN600CO** (set)
3. Trigger **AN600TR**
4. Gas system (for the model ANEL-FOGB = **AN60003BGT** . for the model ANEL-FOGP = **AN60004PGT**)
5. Plug for the diferent model GAS hole
6. Position of GAS bottle connection
7. GAS Valve regulator **AN600GWB**
8. Assembly screws
9. GAS Bottle (for the model ANEL-FOGB = **DF00001** . For the model ANEL-FOGP = **SD60010** )
10. Tank for to be fogged liquid **AN600BT**
11. Vapor nozzle **AN600SC**
12. Heat element protector **AN600FP**
13. Trigger security **AN600SA**
14. Pumping set **AN600PS**
15. Spiral tube **AN600ST**
16. Heat element **AN600GB**
17. Ignitor bottom **AN600SB**
18. Ignitor **AN600FSS**

## Directions for piezoelectric ignitor replacement

1. Unscrew and take out the tank



2. Unscrew the 2 screws that keeps the protector in place from both sides and then remove the Vapor nozzle .

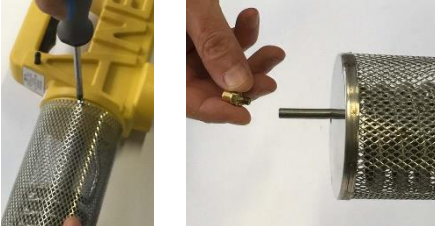

3. Remove the Heat element protector . Maybe you will need to force it a little bit .

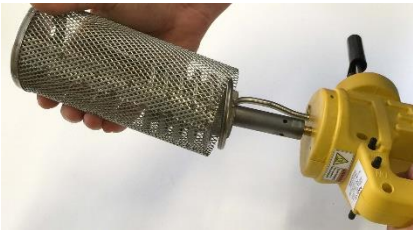

4. Unscrew the screw that keeps in place the GAS Valve regulator and then pull it out until it will be released .



5. By having the fogger at the side unscrew all the assembly screws from the Right cover



6. Pull out carefully the right cover . You will see the internal of the fogger .



7. Pull out smoothly the ignitor by keeping with your free hand steady the body of the fogger .





8. Dispose properly the old ignitor and replace it with the new one . Be sure the naked edge of the wire of the ignitor will be in the same position so it will be in good contact with the spiral tube when the fogger will be reassembled.



9. Before you start the reassembly be sure the parts below are in their place .

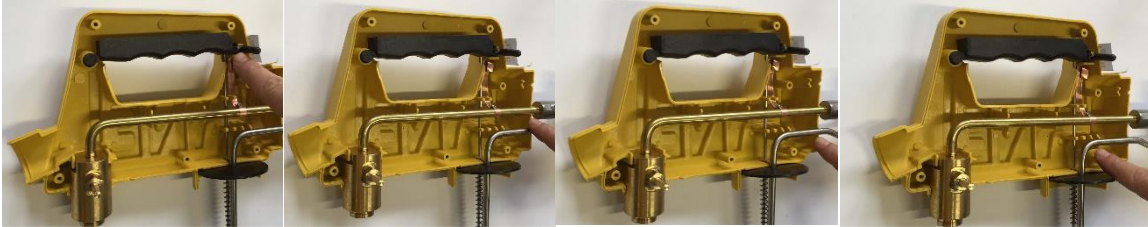

10. Set firmly in this place the right cover and try the ignitor to see if it functions well ..



11. Check the parts below to see if they are in the correct position . If not fix them before you proceed ..



12. Screw the assembly screws that keep together the covers .



13. Place the GAS valve in its place and screw the screw that keeps it in its place on the ax .



14. Place the heat element protection back in its place and Screw the 2 screws that keep it in place .Then screw the Vapor nozzle .

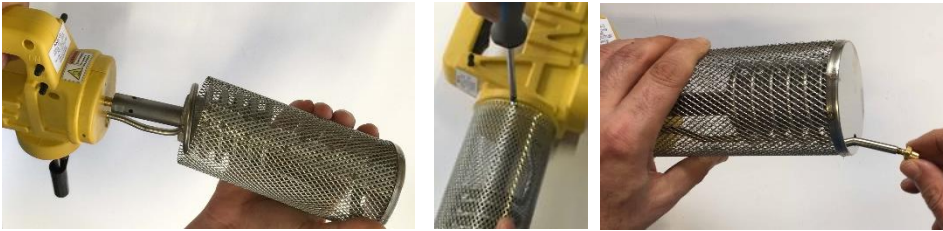

15. Place back the tank in its place
16. Go to a dark room and check if the ignitor sparks . between the spiral tube and the heat element

### Directions for the replacement of the pumping system gaskets:

1. Unscrew and take out the tank



2. Keep with the one hand the one part of the pumping system ( black part ) and with the other hand pull out the ax with the spring so they will be released one from each other .

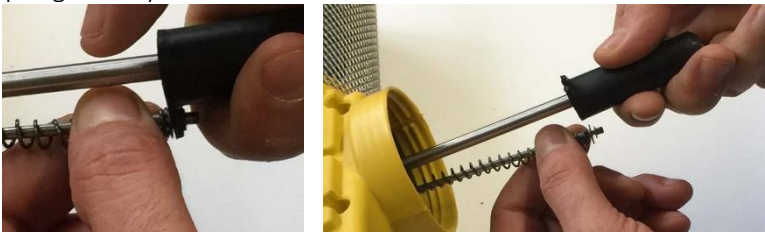

3. Pull out the black tube so you will take it out . Be carefull there is a sphair inside , do not loose it , the system will not work without it .



4. Turn unclockwise the pumping piston untill it will be released from the stainless steel tube Be carefull there is a sphair inside , do not loose it , the system will not work without it .

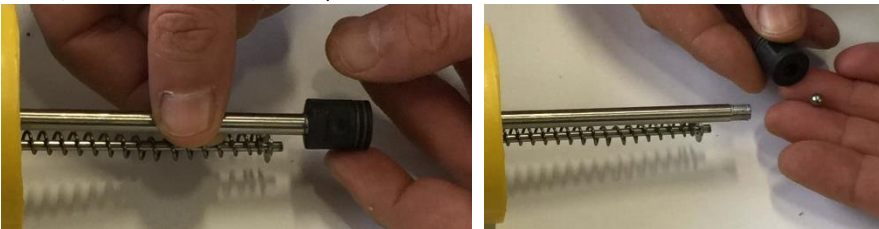

5. With a sharp wooden tool take out the 2 gaskets.



6. Place the new gaskets on the piston as described below .

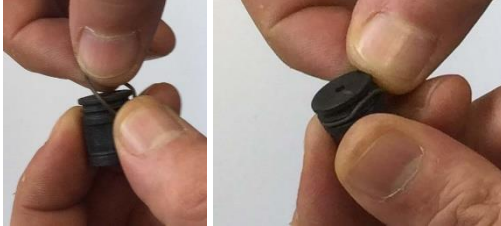

7. Insert the small sphere in the piston and screw it back on the stainless steel tube . Tight firmly by hand but not strong or you will damage it .

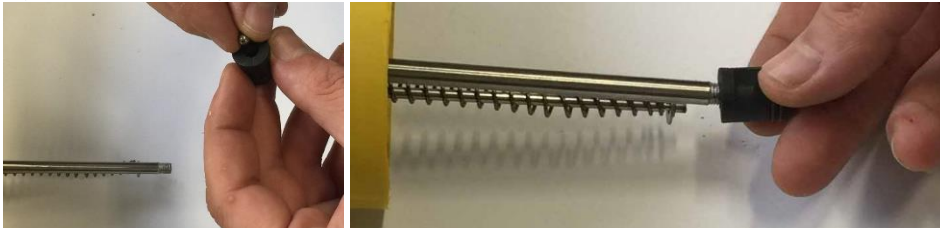

8. Insert the big sphere in the black tube and insert it around the pumping piston .

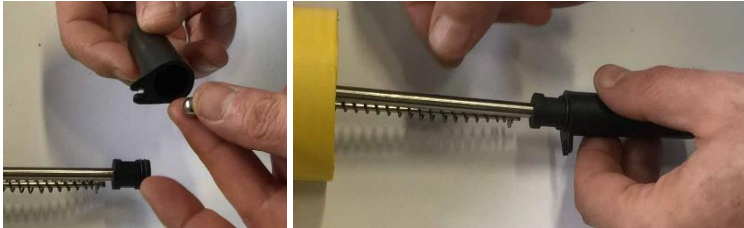

9. Center the gap of connection of the black tube with the stainless steel ax and pushh one on the the other untill you here a characteristic ``click`` . Check to see if the ax has arive untill the center of the gap and that it is firmly sarounded by it .



## WARRANTY INFORMATION

We guarantee that this product is suitable for the use described in this manual and has no material and manufacturing defects. The warranty is valid for 90 days from date of purchase. ANEL Co will repair or replace any defective materials,

after examination / audit by our side of the device. The repair or replacement decision is left to the discretion of ANEL Co. If you want to raise warranty claims, please contact ANEL Co to determine remedies.

This guarantee relates exclusive remedy and does not make us responsible for any secondary, incidental, personal injury or damage to property. No warranty is valid in case of wrong use of the product, negligence or accident, or if it has been damaged during transport or in an accident or if the device has been modified or repaired by unauthorized person or if it is used in a manner inconsistent with the the manufacturer's instructions. This warranty applies only to products of which are held by people who have purchase the product of ANEL Co directly from the ANEL Co or by an authorized distributor or retailer of ANEL Co or a retailer of our network and is valid only for the products we supply . All Rights Reserved subsequent planning application or change of parts after publication without obligation to reissue descriptive forms or lists.

We make no other express warranty. Indirect guarantees, including suitability- and marketability of the product, limited to 90 days from date of purchase by the user. The purchaser must assume all responsibility for use of this product if it is not used according to instructions or failure to comply with the usual safety practices, or when used in abnormal conditions. The manufacturer's liability is stricktly limited to replacement or repair of the product.

NOTE: The limitation on the duration of implied warranty and / or secondary damages may not apply to you, if the legal framework in the area in which you live does not allow its implementation.

CONTACT INFO:

ANEL STANDARD CO – Ε.Ε. ΠΑΝΤΕΛΑΚΗΣ & ΣΙΑ Ε.Ε.

45ης αρ.6

13341 ΒΙΟΠΑ ΑΝΩ ΛΙΟΣΙΑ

ΤΗΛ: (++30) 210 2771180 & 210 2771101 & 210 2483870

FAX: (++30) 210 2771180 & 210 2483870

www.anel.gr info@anel.gr & sales@anel.gr & support@anel.gr